







Pesante • Heavy • Lourd • Schwer • Pesado

 540 rpm
 2300 rpm
 cat.
 1/2

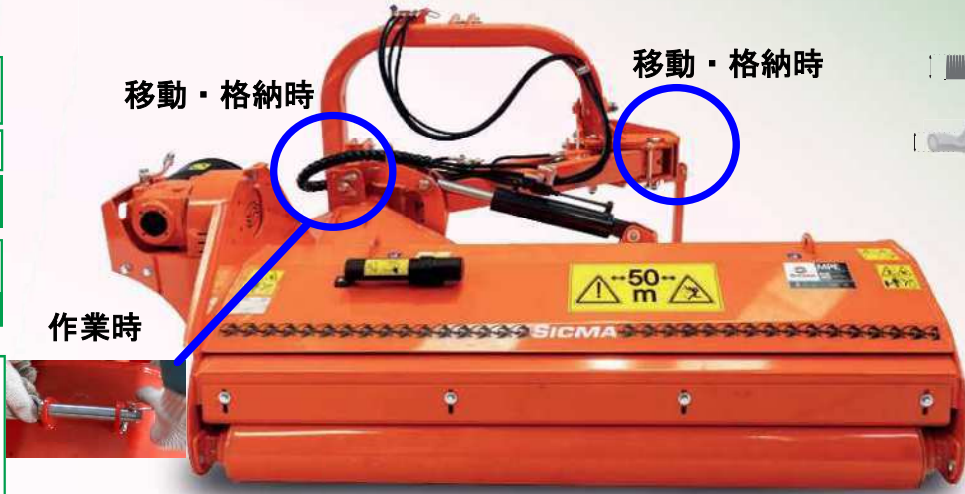

 25/38/52 mm
 40 mm

作業時

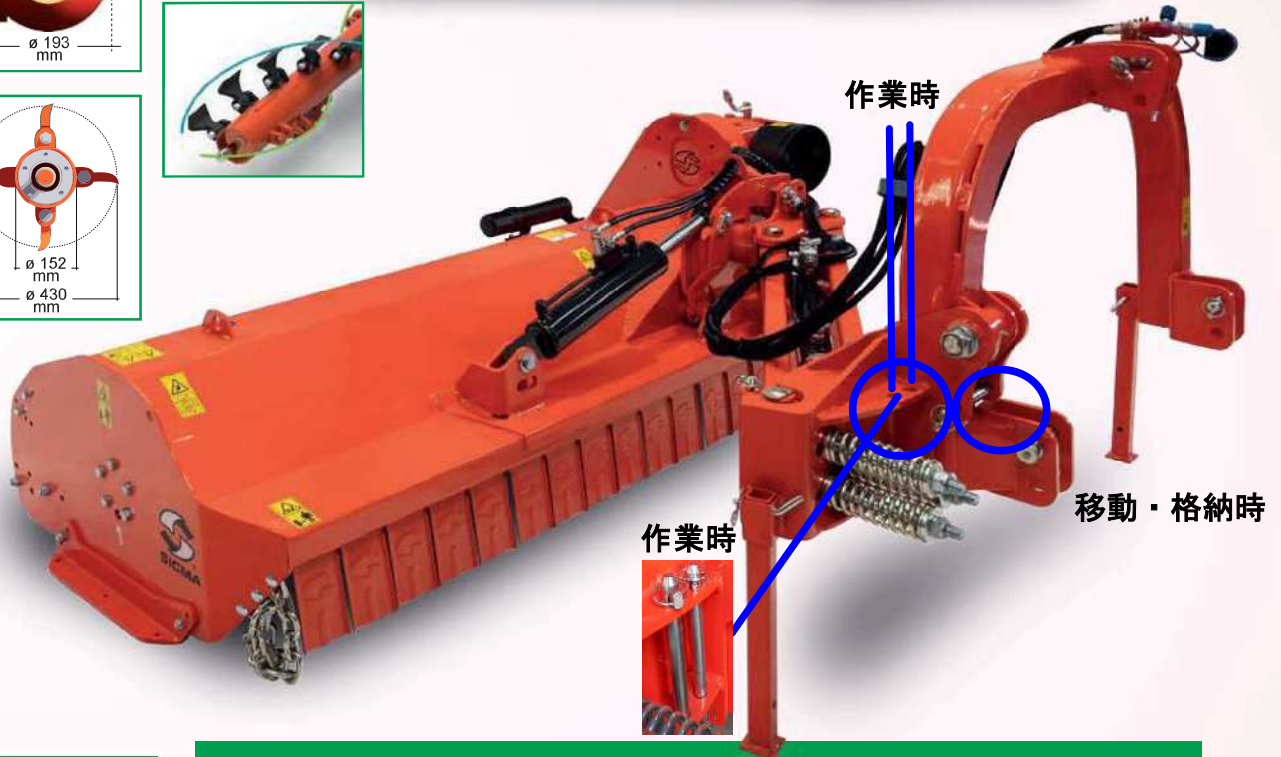
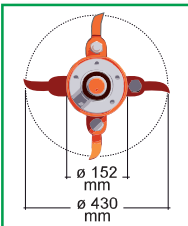

作業時

作業時







移動・格納時



MLE



MLI

MOD	 hp	 mm (in)	 mm (in)	 kg (lbs)	 nr (0,34 kg)	 nr (1,45 kg)	 nr
MPE 160	60 ▶ 130	1600 (62")	2050 (81")	720 (1587)	40	20	4 (XPB)
MPI 160	60 ▶ 130	1600 (62")	1759 (69")	720 (1587)	40	20	4 (XPB)
MPE 180	60 ▶ 130	1800 (71")	2250 (88")	760 (1675)	48	24	4 (XPB)
MPI 180	60 ▶ 130	1800 (71")	1950 (77")	760 (1675)	48	24	4 (XPB)
MPE 200	60 ▶ 130	2000 (79")	2450 (96")	820 (1807)	48	24	4 (XPB)
MPI 200	60 ▶ 130	2000 (79")	2150 (85")	820 (1807)	48	24	4 (XPB)
MPE 230	60 ▶ 130	2300 (90")	2750 (108")	920 (2028)	52	26	4 (XPB)
MPI 230	60 ▶ 130	2300 (90")	2450 (96")	920 (2028)	52	26	4 (XPB)

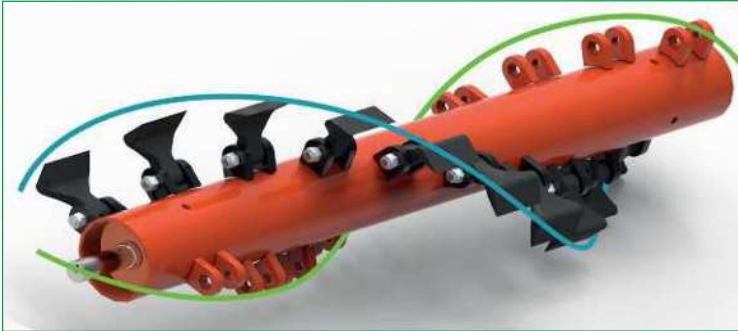

電子バランス式ヘリカルシャフト

- alberone elicoidale equilibrato elettronicamente
- electronically balanced helical rotor
- rotor hélicoïdal à équilibrage électronique
- elektronisch ausbalancierte Spiralwelle
- rotor helicoidal balanceado electrónicamente



平行四辺形油圧サイドシフト

- spostamento laterale idraulico a parallelogramma
- side parallelogram hydraulic shift
- déplacement latéral hydraulique à parallélogramme
- Hydraulische Parallelepiped Seiteverschiebung
- desplazamiento lateral hidráulico a paralelogramo



傾斜速度制御バルブ

- valvola di regolazione velocità inclinazione
- inclination speed control valve
- vanne de régulation à soupape de régulation vitesse d'inclinaison
- regelventil für Sturzgeschwindigkeit
- válvula de regulación de velocidad de inclinación



外部ベルト調整器

- regolazione esterna delle cinghie
- external drive belt adjustment
- régulateur externe de courroie
- aussenregler für Riemen
- regulación externa de las correas



フリーホイール体ギアボックス

- moltiplicatore con ruota libera integrata
- gearbox with integrated free wheel
- multiplicateur de vitesse avec roue libre intégrée
- Übersetzungsgetriebe mit integrierter Freilauf
- multiplicador con rueda libre integrada

トランスミッション保護

- protezione carter trasmissione
- protected trasmission carter
- protection du carter de transmission
- Schutz für Keilriemenantrieb
- protección transmisión carter

- coppia di slitte **サイドスキット**
- Side skids
- kit glissières
- Kufenpaar
- par de deslizadores

- protezioni frontali contro lancio di oggetti
- front protections against accidental ejection of objects
- protections antérieures contre des jets accidentels
- vorderschutz gegen zufälliges Werfen
- protecciones frontales contra el lanzamiento de objetos:



飛び出しを防ぐフロントプロテクター

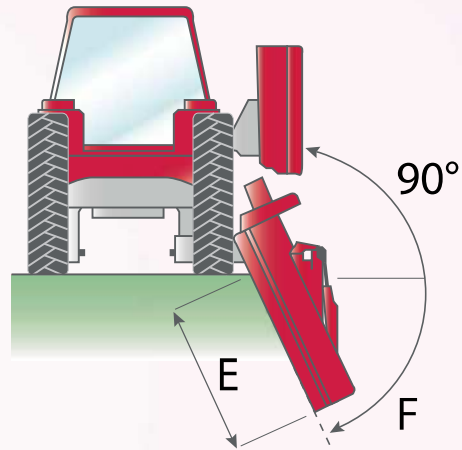
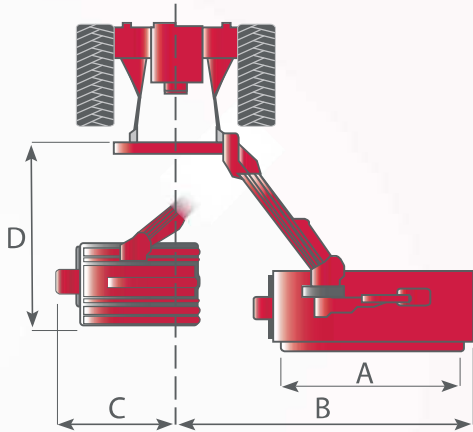

MOD.	A mm (in)	B mm (in)	C mm (in)	D mm (in)	E mm (in)	F °
MM 110	1100 (43'')	1750 (69'')	580 (23'')	1440 (57'')	750 (30'')	50
MM 125	1250 (49'')	1900 (75'')	580 (23'')	1440 (57'')	900 (35'')	50
MA 120	1250 (49'')	1850 (72'')	580 (23'')	1450 (57'')	750 (30'')	50
MA 140	1410 (55'')	2010 (79'')	580 (23'')	1450 (57'')	900 (35'')	50
MLE 140	1410 (55'')	2320 (91'')	650 (26'')	1540 (61'')	1200 (47'')	55
MLI 140	1410 (55'')	2020 (80'')	650 (26'')	1540 (61'')	1050 (41'')	55
MLE 160	1560 (61'')	2470 (97'')	650 (26'')	1540 (61'')	1350 (53'')	55
MLI 160	1560 (61'')	2170 (85'')	650 (26'')	1540 (61'')	1200 (47'')	55
MPE 180	1860 (73'')	3020 (119'')	850 (34'')	1730 (68'')	1600 (63'')	60
MPI 180	1860 (73'')	2740 (108'')	850 (34'')	1730 (68'')	1250 (49'')	60
MPE 200	2010 (79'')	3170 (125'')	850 (34'')	1730 (68'')	1800 (71'')	60
MPI 200	2010 (79'')	2890 (114'')	850 (34'')	1730 (68'')	1400 (55'')	60
MPE 230	2310 (91'')	3470 (137'')	850 (34'')	1730 (68'')	2100 (83'')	60
MPI 230	2310 (91'')	3190 (126'')	850 (34'')	1730 (68'')	1700 (67'')	60